

■
HYDRAULIC HINGE CLOSER

NOSCAVO[®] HHC



INTERMETAL SA PATENT

Absolute Door Closing Control

- WITHOUT FLOOR CORING
- NO MORE FLOOR DAMAGES
- EASY RELOCATION OF THE DOOR
- FOR INTERNAL & EXTERNAL GLASS DOORS

INnovationAL Solutions

hydraulic hinge door closer

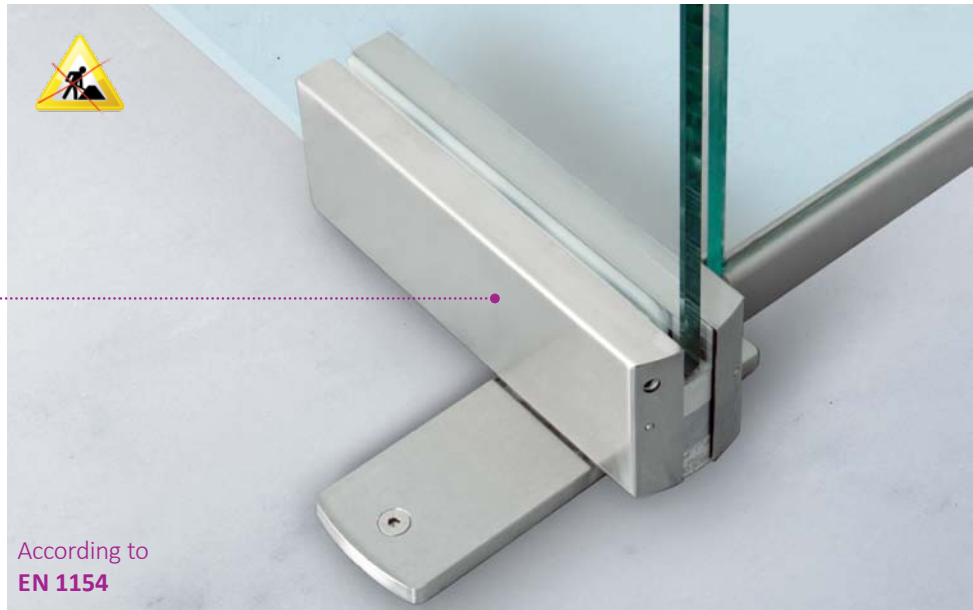

The innovative patent hydraulic hinge INAL® NOSCAVO® replace floor door closers and makes glass doors installation quick & easy. An ideal solution suitable for EXTERNAL & INTERNAL glass door applications.

- No more floor coring
No need to cut marbles, granites, tiles and flooring materials
No more damages in the infrastructures piping, wiring, e.t.c.
- Ideal solution in wooden floors
- Easy relocation of the door
- Immediate restoration of rented premises to their former configuration
- Easy & absolute adjustable door closing control

technical specifications

AVAILABLE IN 3 TYPES

- LIGHT ■ MEDIUM ■ **HEAVY**

■ WITH HOLD OPEN
(STAGES ±90° / ±135° / ±165° / ±180°)

- WITHOUT HOLD OPEN

	DOOR WIDTH	DOOR WEIGHT	GLASS THICKNESS
LIGHT	0,70m	80Kg	10-12 mm
MEDIUM	1,00m	100Kg	10-12 mm
HEAVY	1,10m EXTERIOR	up to 200Kg	H1: 10-12
	1,20m INTERIOR		H2: 13,52 - 17,52

Stainless steel covers (Passivated ASTM A967)

Satin finishing NS100.01.14*

Polished finishing NS100.01.13*

Available in RAL powder coating upon request

* Passivated

INnovational Technology

- Hydraulic high pressure damping value
- Adjustable Latching Starting point- latching moment

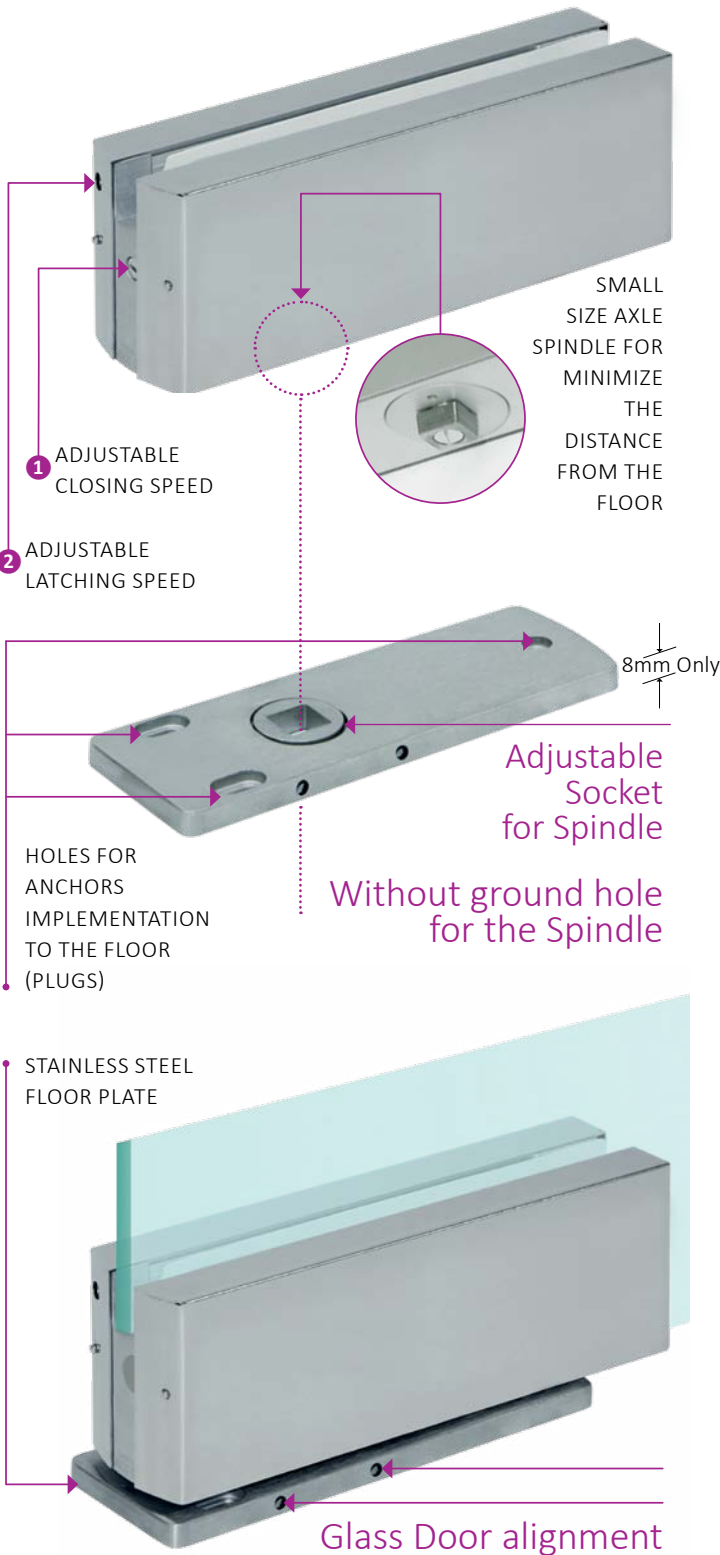

!Quick installation

INSTALL THE SPECIALLY DESIGNED STAINLESS STEEL PLATE ON THE FLOOR, ASSEMBLY THE INAL[®] NOSCAVO HYDRAULIC HINGE TO THE GLASS AND YOU ARE READY TO INSTALL YOUR GLASS DOOR.

adjustment

6mm backward and forward

3mm left and right for parallel shift of the glass door

14° alignment adjustment

TWO ADJUSTMENT VALVES

- 1 For closing speed
- 2 For latching speed
adjustable starting point (latching moment)

maximum door opening

(HOLD OPEN STAGES)
±90° / ±135° / ±165° / ±180°

with hold open

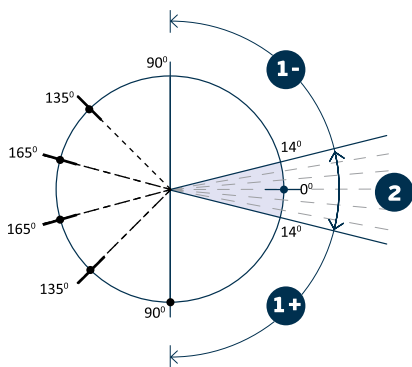

ADJUSTABLE
LATCHING
POINT AREA
(LATCHING
MOMENT)

without hold open

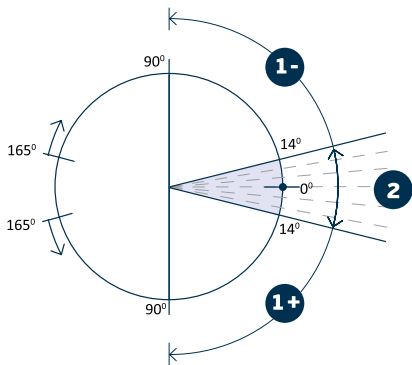

ADJUSTABLE
LATCHING
POINT AREA
(LATCHING
MOMENT)

sections

stainless steel floor plate

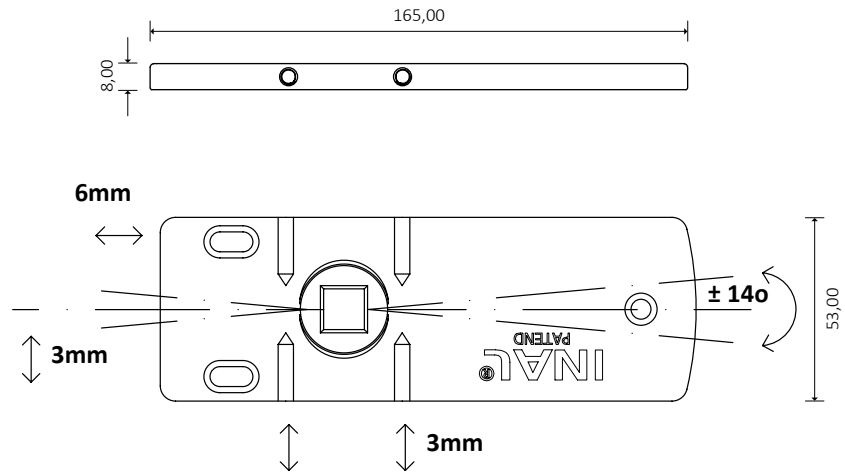

hydraulic hinge

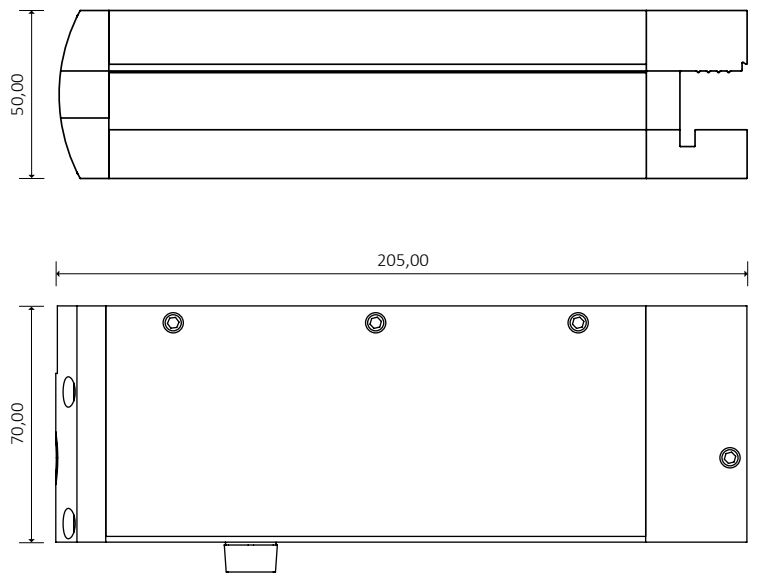

glass cutting

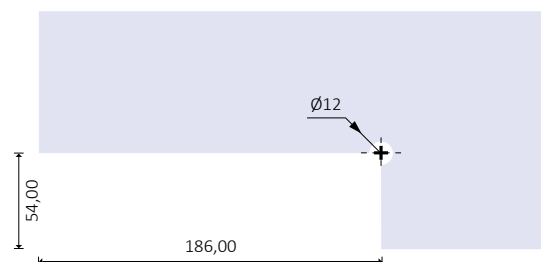

Suitable for EXTERNAL & INTERNAL glass door applications



noscavo DIY Kit

Each **Noscavo** System comes in 2 standard kits to meet each installers' needs.

NOSCAVO KIT: NS A

TOP HINGE

CODE **101**
10mm Glass
Cover Finishing:
Satin Anodised
Polished Anodised
Natural Anodised

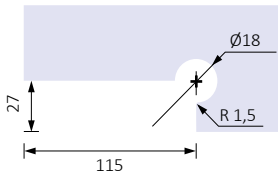

TOP PIVOT

CODE **105L**

STAINLESS STEEL COVERS

SATIN FINISHING

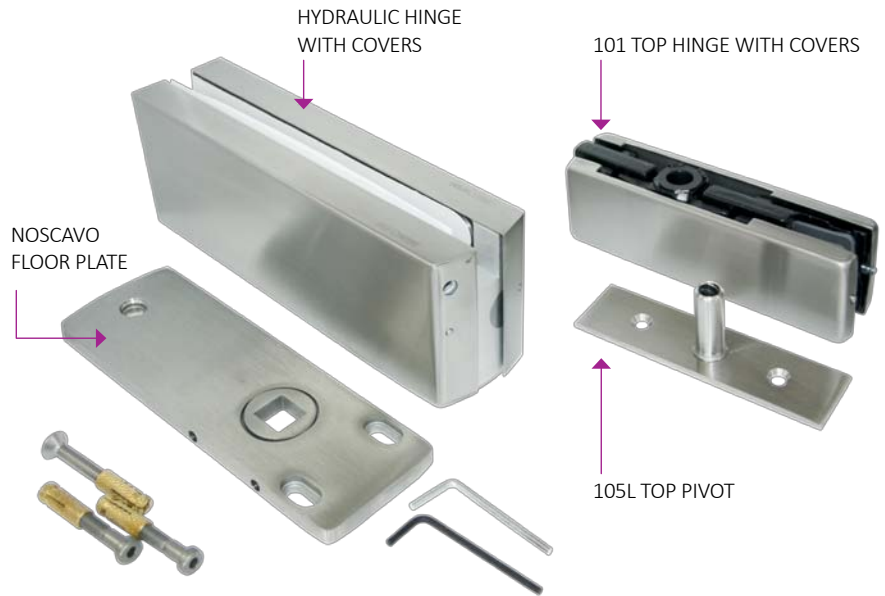

NOSCAVO KIT: NS B

TOP HINGE

CODE **141**
10-12mm Glass
Cover Finishing:
Satin Anodised
Polished Anodised
Natural Anodised

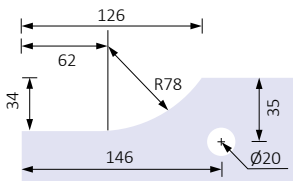

TOP PIVOT

CODE **105.G**

STAINLESS STEEL COVERS

SATIN FINISHING

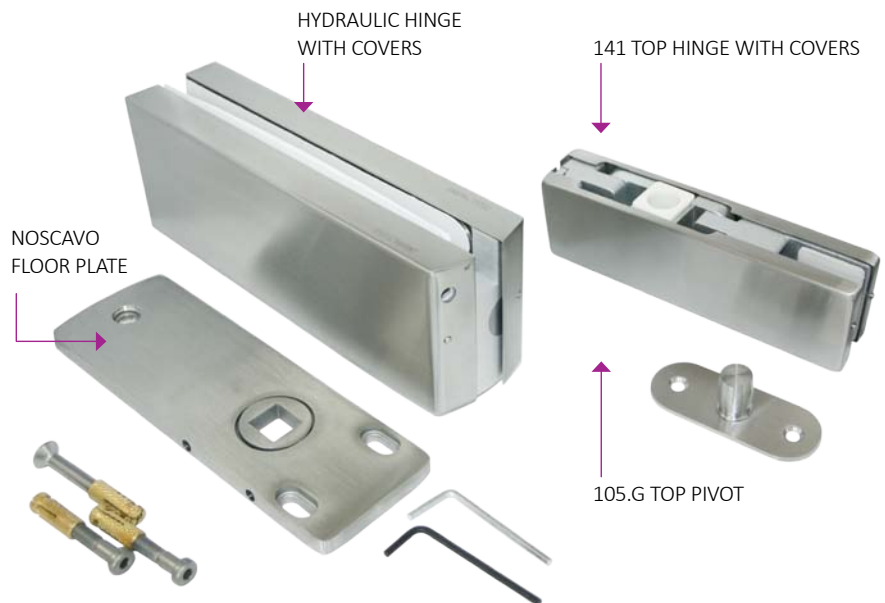

AVAILABLE IN 3 TYPES

■ LIGHT ■ MEDIUM ■ **HEAVY**

accessories

locks



CODE 243
Glass Lock
Cover Finishing .13 .14



CODE 243G
Glass Lock
Cover Finishing .13 .14

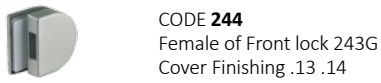

CODE 244
Female of Front lock 243G
Cover Finishing .13 .14



CODE 247
Glass Lock
.15 .16



CODE 247G
Glass Lock
.16

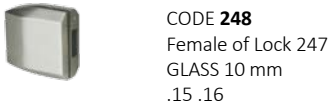

CODE 248
Female of Lock 247
GLASS 10 mm
.15 .16

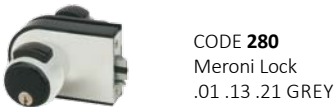

CODE 280
Meroni Lock
.01 .13 .21 GREY



CODE 281
Lock Meroni Female
.07 .13 .21 RAL GREY
COLOUR



CODE 280WC
WC Meroni Lock
.01 .13 .21 GREY

SLOT

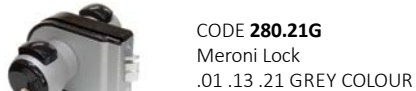

CODE 280.21G
Meroni Lock
.01 .13 .21 GREY COLOUR



CODE 284
Glass Lock Meroni Forma
.21 RAL GREY COLOUR

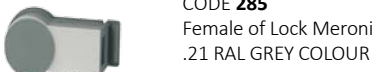

CODE 285
Female of Lock Meroni
.21 RAL GREY COLOUR



CODE 210
Floor Lock (Double Locking)
Cover Finishing .01 .02 .07
.08 .13 .14 .21 .25

! Combine
WITH INAL®
GLASS ACCESSORIES

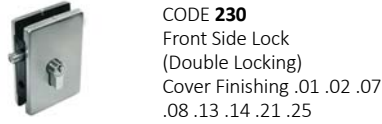

CODE 230
Front Side Lock
(Double Locking)
Cover Finishing .01 .02 .07
.08 .13 .14 .21 .25

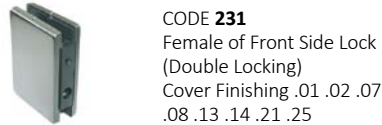

CODE 231
Female of Front Side Lock
(Double Locking)
Cover Finishing .01 .02 .07
.08 .13 .14 .21 .25



CODE 273
Electric Lock with Knob
Left/Right
Cover Finishing .13 .14

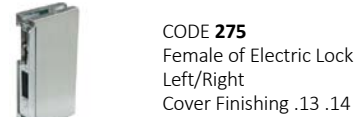

CODE 275
Female of Electric Lock
Left/Right
Cover Finishing .13 .14

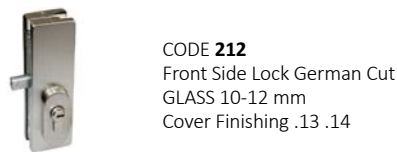

CODE 212
Front Side Lock German Cut
GLASS 10-12 mm
Cover Finishing .13 .14

handles



CODE 640
Inox Handle H
Available in various sizes
Ø18 & Ø32
.13 .14

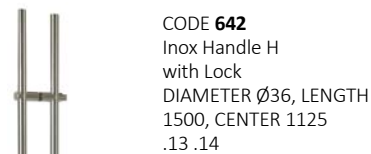

CODE 642
Inox Handle H
with Lock
DIAMETER Ø36, LENGTH
1500, CENTER 1125
.13 .14



CODE 643
Inox Handle H
25x40 with Lock
LENGTH 1500
.13 .14



door handles

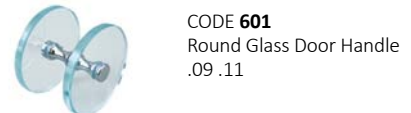

CODE 601
Round Glass Door Handle
.09 .11

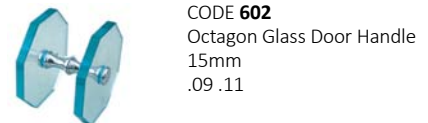

CODE 602
Octagon Glass Door Handle
15mm
.09 .11

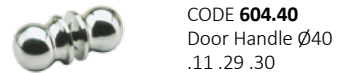

CODE 604.40
Door Handle Ø40
.11 .29 .30

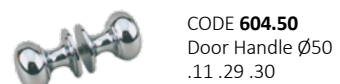

CODE 604.50
Door Handle Ø50
.11 .29 .30

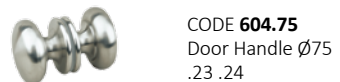

CODE 604.75
Door Handle Ø75
.23 .24

CODE VL 155C
Chameleon
Glass Lock



NOSCAVO HHC HYDRAULIC HINGE CLOSER

HYDRAULIC HINGE CLOSER

NOSCAVO HHC



Absolute Door Closing Control

- WITHOUT FLOOR COILING
- NO MORE FLOOR DAMAGES
- EASY RECALIBRATION OF THE DOOR

INnovationAL Solutions

CERTIFICATE
ACCORDING TO EN 1154

INTERNETAL S.A.
Certifies that the following product:
INAL NOSCAVO Hydraulic Hinge Closer
Has been tested according to EN 1154 European Standards.
Actual test year: 14/09/2018

SEE EN 1154 RATINGS: **1 | 1 | 1 | 1 | 1 | 1 | 1 | 1 | 1 | 1**

Maximum closing speed (maximum holding speed)	100
Maximum opening speed	100
Maximum force (closing)	100
Maximum force (opening)	100

Technical Features:

Material	Aluminum
Material finish	Black
Weight	0.80 kg
Weight (with glass)	1.20 kg
Weight (with glass and handle)	1.60 kg
Weight (with glass and handle and lock)	2.00 kg
Weight (with glass and handle and lock and handle)	2.40 kg
Weight (with glass and handle and lock and handle and handle)	2.80 kg
Weight (with glass and handle and lock and handle and handle and handle)	3.20 kg
Weight (with glass and handle and lock and handle and handle and handle and handle)	3.60 kg
Weight (with glass and handle and lock and handle and handle and handle and handle and handle)	4.00 kg
Weight (with glass and handle and lock and handle and handle and handle and handle and handle and handle)	4.40 kg
Weight (with glass and handle and lock and handle and handle and handle and handle and handle and handle and handle)	4.80 kg
Weight (with glass and handle and lock and handle and handle and handle and handle and handle and handle and handle and handle)	5.20 kg
Weight (with glass and handle and lock and handle and handle and handle and handle and handle and handle and handle and handle and handle)	5.60 kg
Weight (with glass and handle and lock and handle and handle and handle and handle and handle and handle and handle and handle and handle and handle)	6.00 kg
Weight (with glass and handle and lock and handle and handle and handle and handle and handle and handle and handle and handle and handle and handle and handle)	6.40 kg
Weight (with glass and handle and lock and handle and handle and handle and handle and handle and handle and handle and handle and handle and handle and handle and handle)	6.80 kg
Weight (with glass and handle and lock and handle and handle and handle and handle and handle and handle and handle and handle and handle and handle and handle and handle and handle)	7.20 kg
Weight (with glass and handle and lock and handle and handle and handle and handle and handle and handle and handle and handle and handle and handle and handle and handle and handle and handle)	7.60 kg
Weight (with glass and handle and lock and handle and handle and handle and handle and handle and handle and handle and handle and handle and handle and handle and handle and handle and handle and handle)	8.00 kg
Weight (with glass and handle and lock and handle and handle and handle and handle and handle and handle and handle and handle and handle and handle and handle and handle and handle and handle and handle and handle)	8.40 kg
Weight (with glass and handle and lock and handle and handle and handle and handle and handle and handle and handle and handle and handle and handle and handle and handle and handle and handle and handle and handle and handle)	8.80 kg
Weight (with glass and handle and lock and handle and handle and handle and handle and handle and handle and handle and handle and handle and handle and handle and handle and handle and handle and handle and handle and handle and handle)	9.20 kg
Weight (with glass and handle and lock and handle and handle and handle and handle and handle and handle and handle and handle and handle and handle and handle and handle and handle and handle and handle and handle and handle and handle and handle)	9.60 kg
Weight (with glass and handle and lock and handle)	10.00 kg

INTERNETAL
DESIGNERS - MANUFACTURERS

ALSO DOWNLOAD OUR PRODUCT CATALOGUES

BALCONIES - GLASS BALUSTRADE RAILS



- FLOOR MOUNTED GLASS BALUSTRADE RAIL INAL® 12780
- INDOOR MOUNTED GLASS BALUSTRADE RAIL INAL® 12780
- SIDE MOUNTED GLASS BALUSTRADE RAIL INAL® 12780
- FLOOR MOUNTED GLASS BALUSTRADE RAIL INAL® 82785
- GLASS CLAMP INAL® 82775
- GLASS CLAMP INAL® 82785
- GROUND MOUNTED GLASS BALUSTRADE RAIL INAL® 82785
- SPINDLE FOR GLASS BALUSTRADES

INnovationAL Solutions

ALUMINUM (CASE) PROFILE
FOR INTERIOR DOORS & PARTITIONS



"Élégance"

- ALUMINUM CASE PROFILE FOR GLASS DOOR APPLICATIONS
- ALUMINUM PROFILE FOR GLASS PARTITION APPLICATIONS
- ALUMINUM CASE PROFILE FOR WOODEN DOOR APPLICATIONS

INnovationAL Solutions

ALUMINUM CASE PROFILE
FOR INTERIOR DOORS & PARTITIONS

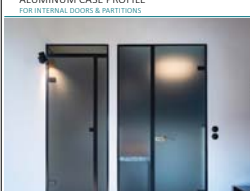

"Flexi"

- ALUMINUM CASE FOR GLASS DOORS
- ALUMINUM PROFILE FOR INTERIOR GLASS PARTITIONS

INnovationAL Solutions

ALUMINUM CASE
FOR GLASS DOORS

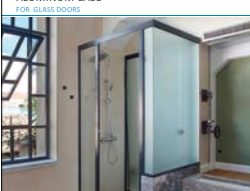

"Simply"

- ALUMINUM CASE FOR GLASS DOORS
- ALUMINUM PROFILE FOR INTERIOR GLASS PARTITIONS

INnovationAL Solutions

ALUMINUM PROFILE
FOR FIXED GLASS PARTITIONS



"Cubo"

- ALUMINUM PROFILE

INnovationAL Solutions

SLIDING SOLUTIONS & APPLICATIONS



- ISO
- MINI CURVED CLAMP
- MINI "CURVED" PROFILE 20mm
- "CURVED" PROFILE 25mm
- "STEREO" PROFILE 30mm

INnovationAL Solutions

SLIDING SOLUTIONS & APPLICATIONS
FOR INTERIOR DOORS & SHOWERS



- T-RAIL BAR
- MINOR SLIDING DOOR SOLID U.S. RAIL
- MINOR SLIDING DOOR U.S. FLAT LINE

INnovationAL Solutions

SWING SOLUTIONS & APPLICATIONS



- "CURVED" PROFILE 25mm
- "STEREO" PROFILE 30mm

INnovationAL Solutions

AUTOMATIC GLASS DOOR SOLUTIONS & APPLICATIONS



- AUTOMATIC SLIDING GLASS DOORS
- AUTOMATIC TELESCOPIC GLASS DOORS
- AUTOMATIC SWING GLASS DOORS

INnovationAL Solutions

Εξαρτήματα Γυαλιού
Glass Accessories

INAL
GLASS SYSTEMS & ACCESSORIES



Designers - Manufacturers

INnovationAL Solutions