

■
ALUMINUM CASE PROFILE
FOR INTERNAL DOORS & PARTITIONS



"Flexi"

- ALUMINUM CASE FOR GLASS DOORS
- ALUMINUM PROFILE FOR INTERNAL GLASS PARTITIONS

INnovationAL Solutions

FLEXI

aluminum case for glass doors





Glass partitioning offers architects, designers, contractors, clients, the ability to create functional and inspirational working and living environments. Leading the pace of the trend, the new aluminum profile "*Flexi*" series from INAL[®] for internal doors, partitions- side fixed glass and overdoor glass panels, provides a unique designed solution with only 23mm height for minimal aesthetic partitions.

The "*Flexi*" profile can be combined with the INAL[®] hinges code 170.BB, 170V.BB and 170.30.BB with door opening up to 147°. Hinges fixing plates are specially designed to support safely the glass door. Provided in the same finishing and color effects with the case profile, offer the perfect image to your application.

Additional rubber gasket "Ω" fitted around the case to provide sealing and silent closing.

Finishing: Aluminum Natural colour Anodised, Satin Anodised & RAL colours upon request.

For a perfect application we recommend INAL[®] locks VL 155C Chameleon, 243G, 247G, 280, 280WC and bolts 910, 910C, 903G.

Only 23mm height!!

Elegant design



product details



Detail corner connection (external)



Detail corner connection (internal)



Sealing rubber gasket

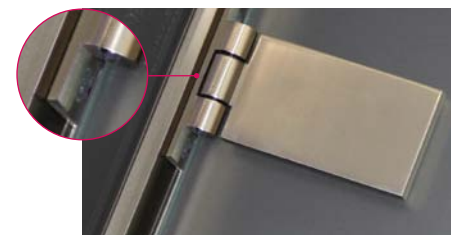

CODE **170.BB**
with safety fixing plate

Detail "T" connection

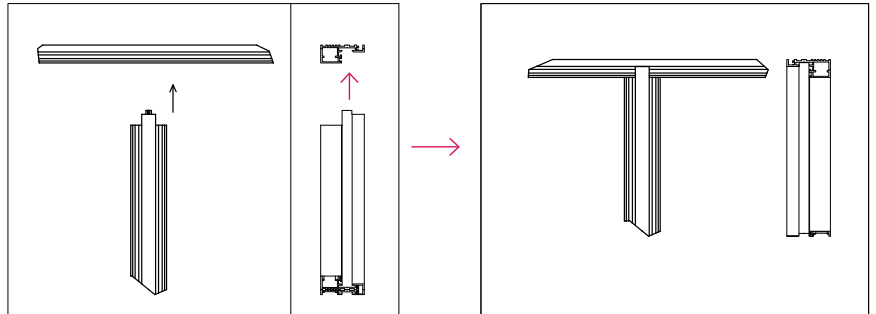

Detail "Linear" connection

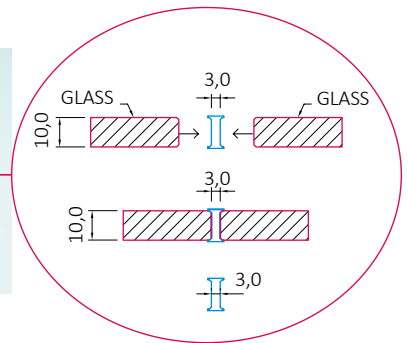

CODE **1446.10.30**
Polycarbonated profile 3m for 10mm glass

Detail "Cross" connection

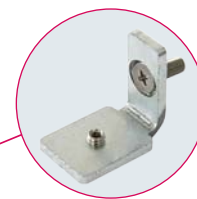
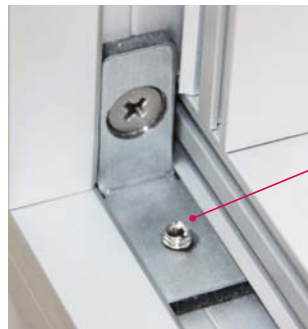

CODE **KFL.010.01.31**
Cross connection support angle (M5-conehead screw M5) Aluminum case "Flexi"- "Simply"

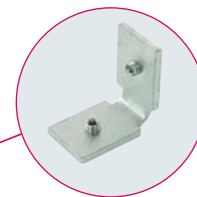

CODE **KFL.010.02.31**
Cross connection support angle (M5-M5) Aluminum case "Flexi"- "Simply"

Aluminum case application



The "*Flexi*" aluminum case profile is a minimal glass partition application, which can be combined with tempered glass, laminated glass and double glazing from 8mm up to 22mm thickness. With the use of special designed connectors (page 4) can be a complete solution for linear, "T" or cross connection of glass internal separation, according to the architectural requests and space requirements. Combined also with slim line hinges INAL[®] code 170.30.BB & glass tilt support INAL[®] code KFL.011 for an air ventilation solution.

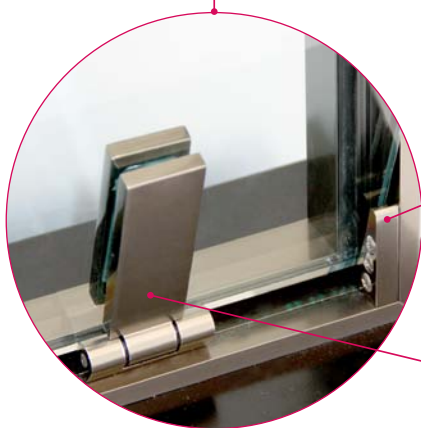

CODE **KFL.011**
Glass tilt support (window)
Aluminum case "Flexi"

INAL[®] CODE
170.30.BB

! Combine
THE GLASS DOOR WITH INAL[®]
GLASS ACCESSORIES



Creating privacy

Creating privacy with INAL® interior partitions. Made according to your specifications, INAL's unique interior partitions are manufactured in the finishing of your choice.

Internal partitions can increase privacy and visibility at the same time to your working space or office. We can make interior partitions upon your request, in order to create a unique style for you. By using glass inner partitions we will create a modern, comfortable office.



!Combine
WITH INAL®
GLASS ACCESSORIES

plan view- section

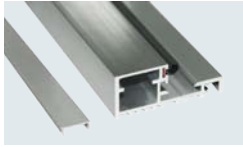

Aluminum profile

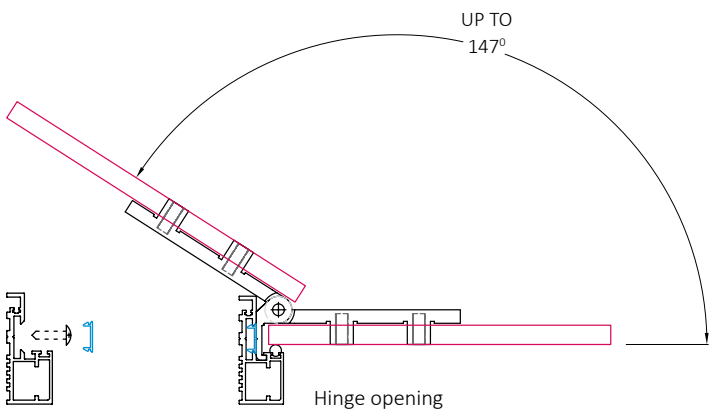
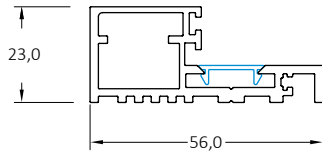

aluminum profile for fixed glass

FOR 8-12mm GLASS

CODE **KF812B**
.00 .01 .25

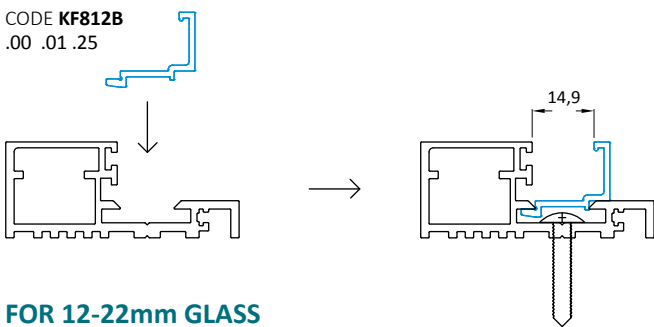

FOR 12-22mm GLASS

CODE **KF1222B**
.00 .01 .25

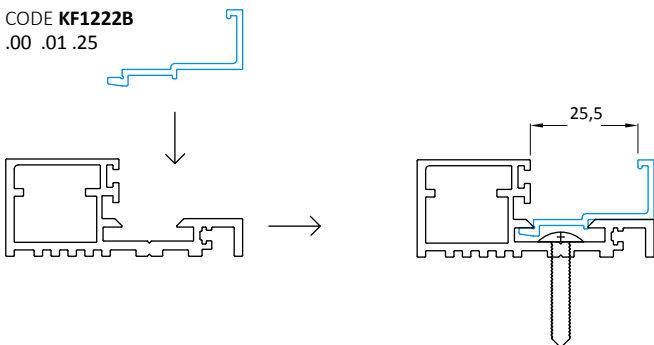

accessories

hinges

CODE **170.BB**
Hinge Glarit
G-W Big Base
.01 .21 .25



CODE **170V.BB**
Vertical Hinge
Glarit G-W
.01 .25



CODE **170.30.BB**
Hinge Glarit G-W
30mm
.01 .25



locks

CODE **VL 155C**
Chameleon
Glass Lock



CODE **243G**
Glass Lock
.13 .14



CODE **247G**
Glass Lock
.16



CODE **280**
Meroni Lock
.01 .13 .21 GREY



CODE **280WC**
WC Meroni Lock
.01 .13 .21 GREY



bolts

CODE **903G**
Bathroom Lock
with Indication
.13 .14



CODE **910**
Door catcher
with knob
.01 .25



CODE **K100-10**
Door Ball Catcher



"Flexi" ALUMINUM CASE PROFILE FOR INTERNAL DOORS & PARTITIONS

INAL[®]
GLASS SYSTEMS & ACCESSORIES

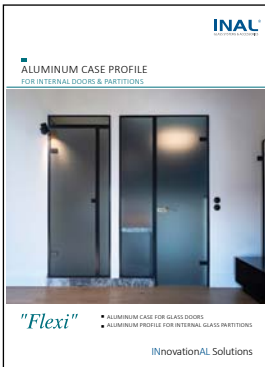

ALSO DOWNLOAD OUR PRODUCT CATALOGUES

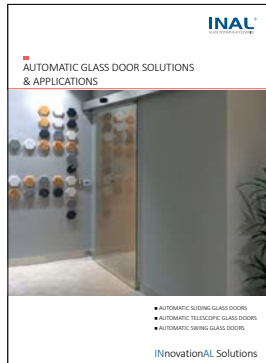
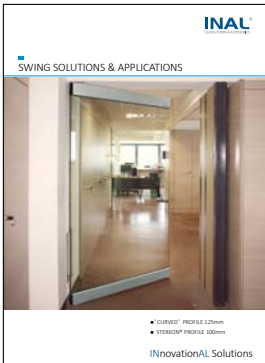
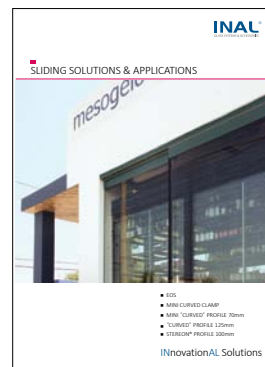

INnovationAL Solutions

INTERMETAL
BUILDING INDUSTRIAL EQUIPMENT

HEADQUARTERS / FACTORY:

6, APOLLONIOU STR., KOROPi 194 00, ATTICA-GREECE,
TEL.: +30 210 6620 400, FAX: +30 210 6620 401
intermetal@inal.gr



ISO 9001 : 2015
CERTIFIED

www.inal.gr

[f Inal.gr](https://www.facebook.com/Inal.gr)

[in company/intermetal-sa](https://www.linkedin.com/company/intermetal-sa)